

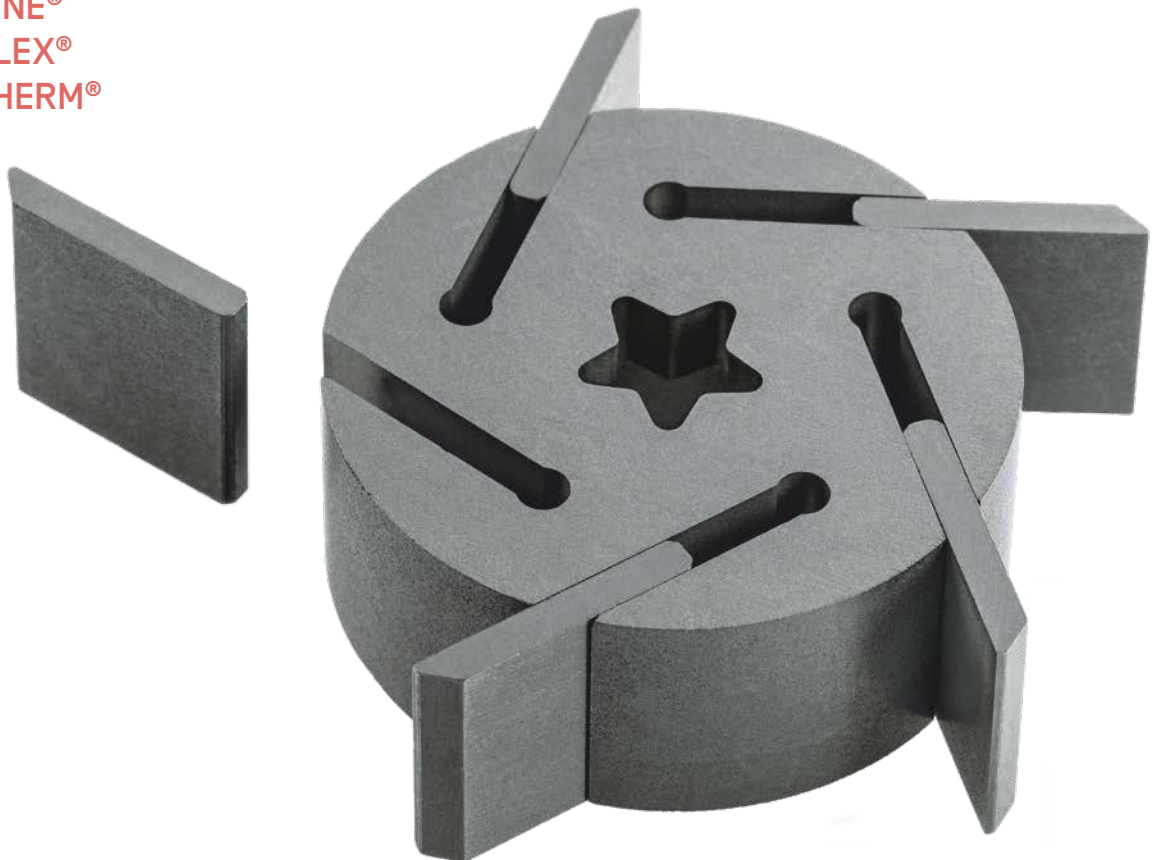

The Emissions Reducer

Our specialty graphites for the automotive industry

SIGRAFINE®
SIGRAFLEX®
SIGRATHERM®



Graphite Materials & Systems

30,000

SIGRAFINE[®] pressed-to-size Plain bearings made out of carbon graphite for cooling medium pumps Boost efficiency, reduce consumption

A water pump running on bearings made of SIGRAFINE specialty graphites will run for up to 30,000 hours — remarkable performance by itself. But our materials also offer major secondary benefits that keep pumps running more efficiently. The benefits are clear: graphite's self-lubricating properties let a pump run unlubricated in media that are not conducive to lubrication. Modern smart pumps operate decentrally and solely on demand. The low coefficient of friction for our SIGRAFINE specialty graphites leads to lower breakaway torques, which in turn cuts energy consumption significantly.

oo



Our specialty graphites for the automotive industry

Make a contribution to higher efficiency and lower emissions: Reap the benefits of the extraordinary material properties and quality of our products for the type of applications found in automotive manufacturing.

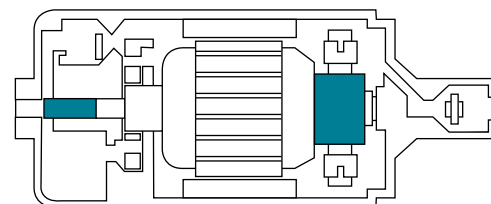
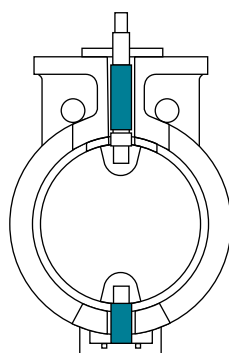

Typical applications

Emission control

- Exhaust gas recirculation valves
- Exhaust gas recirculation coolers

Fuel/water pumps

- Electric fuel pumps
- Electric water pumps

Materials made of carbon and graphite

- Bearings
- Graphite foils

- Seal rings
- Bearings
- Commutator discs

SGL Carbon products

- SIGRAFINE® die-molded carbon and graphite
- SIGRAFLEX® flexible graphite

- SIGRAFINE® die-molded carbon and graphite
-

Notable features

Strong thermal resistance, good self-lubricating properties, corrosion resistance and high mechanical strength.

Our graphite materials boost efficiency in your temperature management, brake servo, exhaust gas management, fuel delivery and convenience functions.

Take advantage of our application-technical expertise.

We are glad to advise you on how to optimize your processes and will work with you to find specific solutions to your needs.

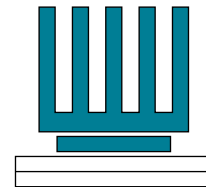
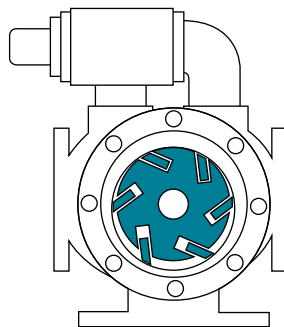

Gaskets

- Mechanical seals for cooling water pumps
- Cylinder head gaskets
- Turbocharger gaskets
- Diesel particulate filters
- Various elastomer/polymer gaskets

- Seal rings
- Graphite foils
- Powder

- SIGRAFINE® die-molded, isostatic carbon and graphite
- SIGRAFLEX® flexible graphite

Electric brake assist pumps

- Electric vacuum pumps

- Rotors
- Vanes

- SIGRAFINE® die-molded, isostatic carbon and graphite

Thermal management

- Batteries
- Pumps
- Dashboard
- Armrests
- Vehicle interior
- Engine compartment

- Graphite foil
- Lightweight boards
- Powder
- Graphite/PCM materials

- SIGRAFLEX® flexible graphite
- SIGRATHERM® products made from flexible Graphite
- SIGRATHERM® ePCM

Applications for the automotive industry

They are self-lubricating, highly resistant to heat and corrosion, and can handle heavy compressive stresses. Our SIGRAFINE graphite products are ideal components in vane-type pumps, fuel and water pumps, commutators, bearings and exhaust gas recirculation.



Water pump with mechanical seal

SIGRAFINE® specialty graphites for vacuum pumps



↑ Rotor and vanes for brake assist pumps



↑ Vacuum pumps comfort seat function

Smart brake boosters

Modern gasoline and diesel motors no longer provide sufficient vacuum power to maintain brake boosters and other technical systems. An on-demand vacuum pump instead delivers the necessary vacuum power in an efficient manner. The same design is found in hybrid and electric vehicles as well.

Efficient and robust

Our rotors and vanes produced from specialty graphites or synthetic resin-bonded materials have made a name for themselves for their exceptional strength and very good sliding properties. This promotes greater energy efficiency and a longer service life for the pumps.

Economical

Pressed-to-size (PTS) technology (see page 13) reduces the need for follow-up machining of the rotors, which in turn saves time and money.

SIGRAFINE® products for brake booster pumps and pumps for convenience applications

Applications	SIGRAFINE products
Rotors	EK2230, EK2231
Vanes	V2048, EK64, V1626

SIGRAFINE® specialty graphites for fuel and water pumps



↑ Bearings made of carbon graphite

Media resistance for higher safety

Safe and reliable transportation of water and fuel throughout the vehicle are of the utmost importance. Our specialty graphites for bearings and gaskets play a big role in this, as they are ultra media resistant and thus highly process-reliable. This is especially important in fuel pumps working with the new generation of fuel/alcohol mixes.

Benefit: Self-lubrication

There are also benefits from the self-lubricating properties of graphite: the significant reduction in friction correlates into greater efficiency; noise emissions are also significantly cut, which can be a major factor when as many as five supplementary pumps are in use.

Documented quality

Our products have achieved various quality certifications, including IATF16949, for years.

Pressed-to-size cuts costs

Pressed-to-size (PTS) technology lets us adapt parts with up to 80 millimeters of outside diameter into an almost perfect match of their final form (see page 13). This minimizes – or even completely eliminates – the need for follow-up machining work. This procedure can pay for itself starting with unit counts of just 2,500.

Application-specific suitability of the materials

Applications	Products	SIGRAFINE			
		EK23 ¹⁾	EK25 ¹⁾	EK33 ¹⁾	EK79
Fuel pumps	Bearings	●	●		
	Seal rings	●	●	●	
	Commutator discs ²⁾	●			●
Water pumps	Bearings	●	●		
	Seal rings	●	●		

¹⁾ Information refers to the base material only. Different impregnations are available. ²⁾ Please also see the following page.

SIGRAFINE® specialty graphites for commutator discs in electric motors

Higher resistance than copper

Given the increase use of fuel mixes featuring a high share of ethanol, commutator discs made of specialty graphites are playing an increasingly important role in electric motors for fuel pumps. These materials are inherently much more corrosion resistant than standard copper discs, making them better suited as components in fuel pumps. This is especially true when striving for compliance with safety and endurance specifications.

SGL Carbon supplies commutator discs of pure electrographite, produced at temperatures of approx. 3,000 °C, as well as hard carbon discs filled with graphite components and produced at a temperature of approx. 1,000 °C. The carbon graphite family of materials are extremely well suited for the production of high-precision discs. These special graphites represent a tremendous combination of carbon's outstanding material properties and the potential for cost-efficient large-scale serial production. These results can be achieved thanks to the pressed-to-size (PTS) manufacturing process. The discs are pressed on fully automated high-frequency presses to achieve the desired final contour and shape. Standard fire shrinkage is then the only significant factor in determining the geometric alignment of the press tool when working with this material. SGL Carbon works solely with high consistency materials and precision press feeds to ensure that we can deliver the promised tolerances. Little to no post-production machining is then required.

Another benefit of the PTS process: extensive freedom in geometric design. As with injection molding and die cutting, this process also allows for offsets, fluting and profiling on the top surfaces of the discs without expensive and time intensive post-production machining. A broad range of design options are available, so long as they adhere to the basic rules of materials and processing technology. Please don't hesitate to contact us for help in developing or optimizing your concepts and geometries.



↑ Commutator disc for fuel pump motors

SIGRAFINE® and SIGRAFLEX® specialty graphites for seals



↑ PTS seal rings made of die-molded carbon



↑ SIGRAFLEX foil

Performance, safety, emissions reduction

Seals naturally play a central role in achieving top driving performance without compromising on safety or emissions. For years we've proudly served as a trusted partner to the automotive industry, delivering materials and products of proven quality and value.

Tried-and-tested gaskets

Our SIGRAFINE fine-grain graphite sealing rings, such as those used in turbocharger seals, are known for their abrasion and temperature resistance as well as their excellent sliding characteristics. They have become trusted components for many automotive manufacturers.

Unparalleled oxidation resistance

Our SIGRAFLEX foils produced from expanded graphite feature long-term stability in their sealing performance and are extremely reliable in a wide range of extreme operating conditions. In particular, our SIGRAFLEX APX2 foil is the clear material of choice when it comes to oxidation resistance. More on page 23.

Carbon and graphite powders improve PTFE and other plastic compounds

We also deliver high-quality carbon and graphite powders for PTFE and other compounds. These fillers deliver significantly better material performance, with significantly reduced material loss in tribological systems and improved thermal and electrical conductivity.

Application-specific suitability of the materials

Applications	Products	SIGRAFINE					SIGRAFLEX		
		EK23 ¹⁾	EK33 ¹⁾	EG31	EG32	V1032	KG19	A	APX2
Mechanical seals	Seal rings	●	●						
Turbocharger gaskets	Seal rings		●						
Cylinder head gasket	Graphite foils							●	
Diesel particulate filters	Graphite foils								●
Plastic compounds	Powder			●	●	●	●		

¹⁾ Information refers to the base material only. Versions with different impregnations are available.

SIGRAFINE® specialty graphites for exhaust applications

Helping reduce emissions

The entire automotive industry is focusing closely on reducing hazardous emissions. Smart exhaust gas recirculation systems, which cut the production of nitrogen oxides and lower fuel consumption, represent one important step in this direction. Our high-performance bearings exhibit precisely the properties needed for those systems' crucial components.

Resistant, low-wearing high-performance bearings

Our bearings are built from graphite, carbon graphite and expanded graphite. The extraordinary resistance to temperature and aggressive gases makes this material a superior choice over alternative products. The bearings also run quiet and with minimal wear thanks to the material's outstanding sliding properties.



↑ Exhaust gas recirculation flap

Application-specific products for Exhaust Gas Recirculation systems (EGR)

Applications	Products	SIGRAFINE			SIGRAFLEX	
		V2142	V2064	EK23	APX2	AP
EGR valves	Bearings	●	●	●	●	
EGR gaskets	Seal rings				●	●
Exhaust manifold	Seal rings				●	●

²¹ See chapter "SIGRAFLEX and SIGRATHERM," page 22

SIGRAFINE® materials and their properties

Outstanding mechanical, thermal and chemical properties – especially in thermal and media resistance – make our specialty graphite the go-to choice for a multitude of automotive applications.



A manufacturing process that generates quality

The outstanding properties of our SIGRAFINE graphite and carbons – corrosion and thermal resistance, gliding ability, electrical conductivity, among others – are benefits of our special production process (shown right). The seven phases from high quality raw material to final product ensure consistent composition of the crystalline graphite structure; targeted changes to the process steps and the formulation needed to influence the behavior of the material according to need. This opens the door to near-net-shape pressing, a potential cost savings driver.

Increased cost-effectiveness: PTS technology

We can implement pressed-to-size technology (PTS) in many areas: Near-net-shape pressings make it possible to manufacture complex component parts in large numbers at low materials usage. Since mechanical end machining is entirely or largely unnecessary, this process is especially cost-efficient.

Impregnation for optimized properties

Metal, phosphate, and synthetic resin impregnations improve physical properties, reduce wear and increase thermal resistance. We impregnate our SIGRAFINE specialty graphites with metals and metal alloys such as antimony as well as synthetic resins and salts.

All carbon – the universal alternative

Our portfolio also includes various synthetic resin-impregnated graphites, with the synthetic resin subjected to a subsequent carbonization process. This offers good media resistance and can be universal used in temperatures up to 350 C°.

Manufacturing process

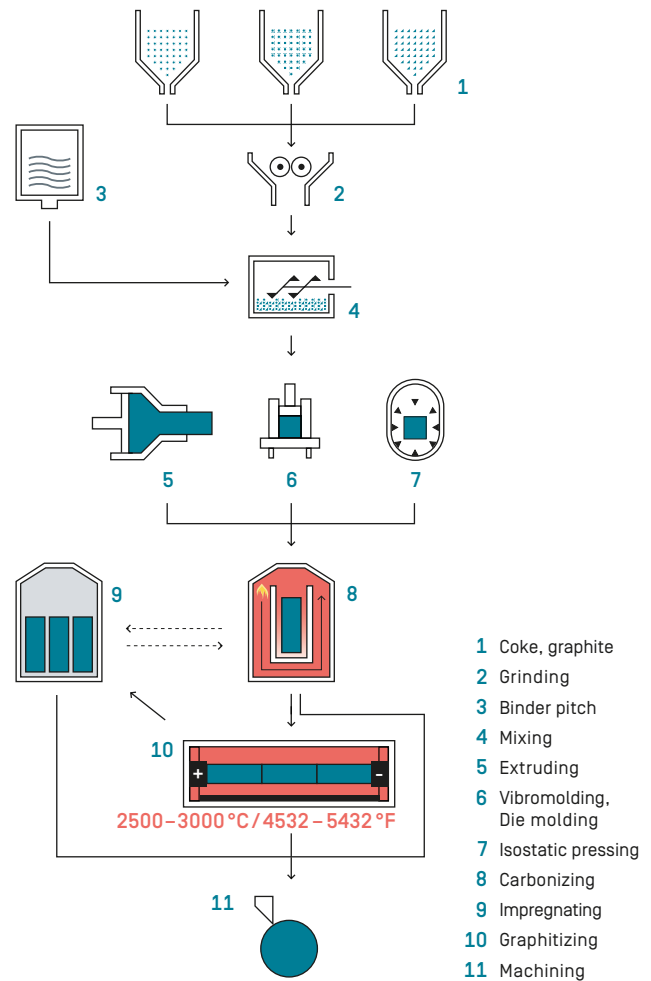

Material properties of our various SIGRAFINE® fine-grain graphites

Typical properties	Units	Die-molded carbon and graphite						Isostatic graphite	
		EK23	EK25	EK33	EK64	V2142	V2064	V1626	V1626
Density	g/cm ³	1.75	1.69	1.6	1.72	1.85	1.83		1.85
Hardness	Rockwell B	105	100	110	90	103	56		90
Flexural strength	N/mm ²	40	45	73	70	80	54		58
Young's modulus	GPa	14	16	16	16	15	16		13
Thermal expansion (20 – 200 °C / 68 – 392 °F)	10 ⁻⁶ K ⁻¹	5.0	4.5	5.1	4.0	4.7	6.3		4.0
Thermal resistance in oxidizing atmosphere	°C	350	350	350	220	550	600		600
	°F	622	622	622	428	1022	1112		1112

Wear Properties

Low wear and long-term stability

Our die-molded graphites and carbon graphites exhibit low material wear, which leads to a longer service life. Our broad portfolio and wealth of materials expertise allows us to offer graphite types that optimally match the respective partner material. This is particularly impactful in combination with rotors and vanes.

Application competency and materials consulting

Many factors influence wear behavior: material pairing, sliding speed, strain, finish of bearing surfaces and operating conditions. We take a holistic view of the tribological system to find the material solution best suited to your specific requirements.

Variety with low wear rates

Wear behavior of some SIGRAFINE material types in wet running conditions

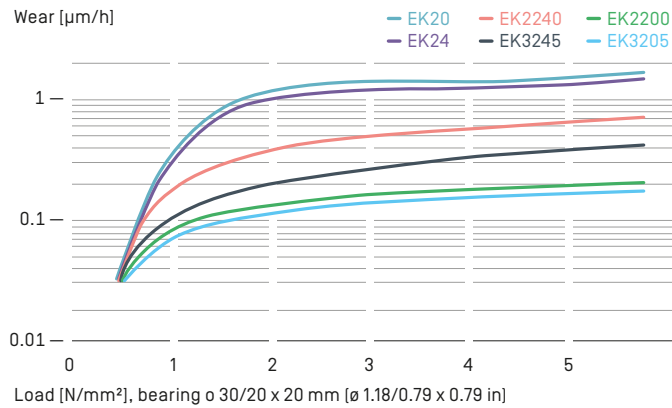

Wear behavior of some SIGRAFINE material types in dry running conditions

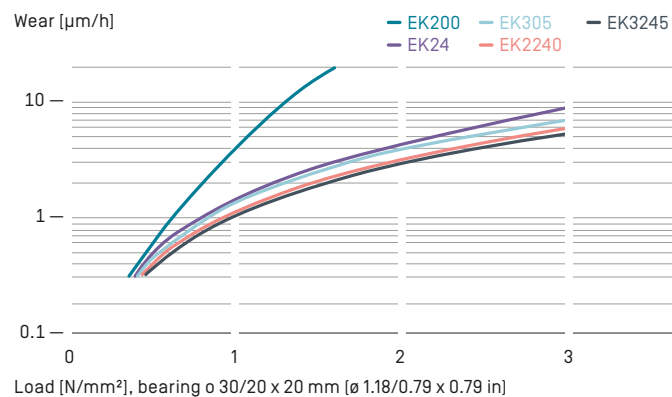

↑ PTS flange bearings

Variety in friction

Coefficient of friction depending on temperature in SiC discs (Ra=0.2)

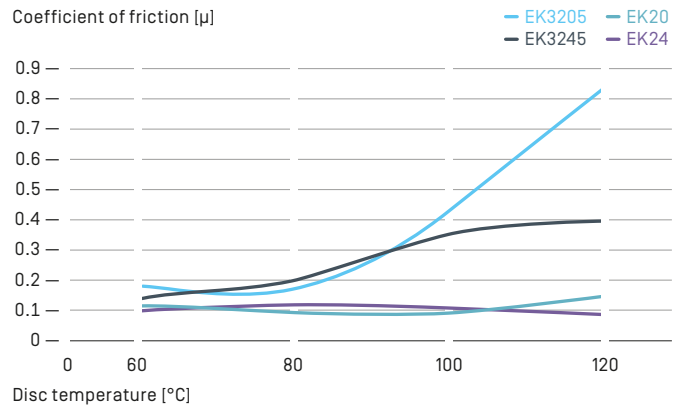

Coefficient of friction depending on temperature in gray cast iron 20 (Ra=0,3)

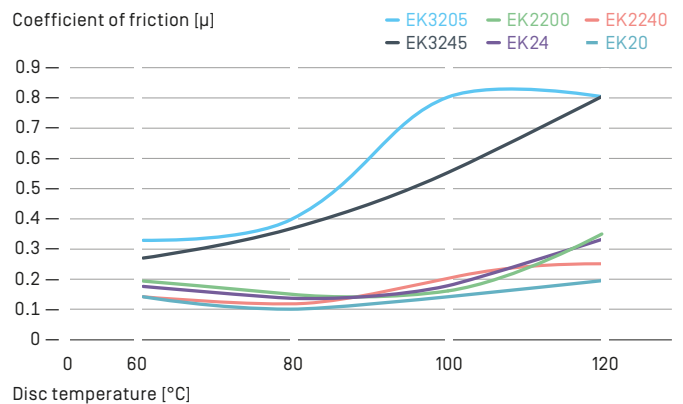

The coefficients of friction were determined in a pin-on-disc test at 11 m/s (36.1 ft/s), a relative relative air humidity between 36% and 43% and a heated disc.

Thermal Conductivity

Thermal conductivity – a key property

SIGRAFINE materials convince with excellent thermal conductivity. It is usually more pronounced in graphite than in the surrounding components, thereby preventing overheating and excessive abrasion, and extending the service life of the system.

Clearly defined thermal-conductivity behavior

Thermal conductivity of different materials

Thermal conductivity [$\text{Wm}^{-1}\text{K}^{-1}$]

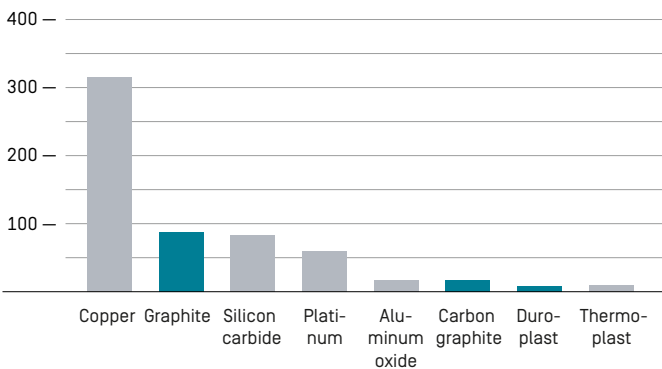

Low expansion in heat

Coefficient of thermal expansion of various materials

Coefficient of thermal expansion [10^{-6}K^{-1}]

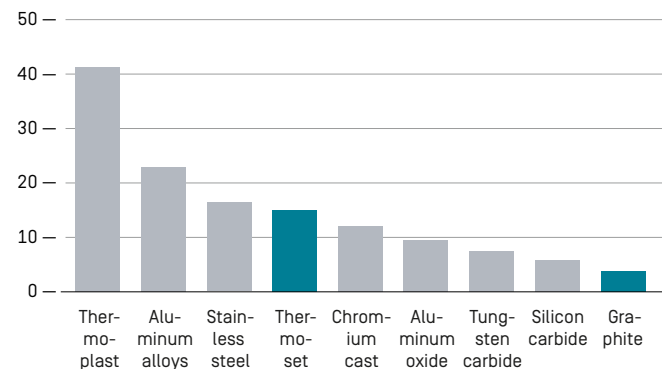

Resistance to thermal shock

Safety from temperature and thermal shock resistance

Of all known materials, graphite has the highest temperature-change resistance. Thanks to these properties, SIGRAFINE materials of graphite and carbon-graphite contribute significantly to process reliability.

Control uniform expansion behavior

Good physical compatibility of the materials employed is also relevant. To achieve this, they must display the same or similar thermal expansion coefficients.

Our broad portfolio and deep wealth of materials expertise allows us to offer optimal graphite types for the respective partner material. This is particularly impactful in combination with rotors and vanes.

We are glad to advise you. Take advantage of our in-depth application know-how!

The clear leaders in temperature-change resistance

Thermal shock resistance of various materials

Thermal shock resistance [%]

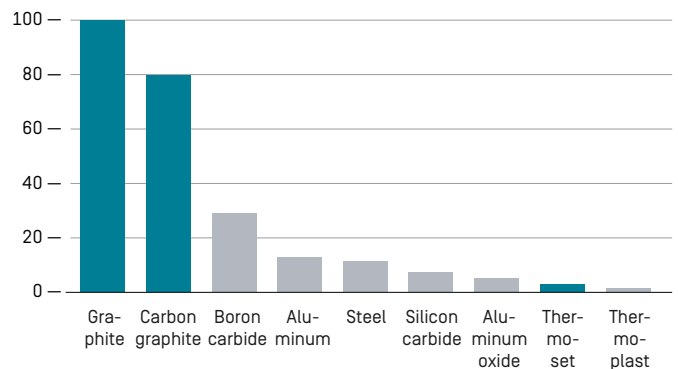

Information on parallel partners and construction

Optimum system performance is achieved by selecting the suited SIGRAFINE type and impregnation as well as by the appropriate construction based on the recommendations shown here.

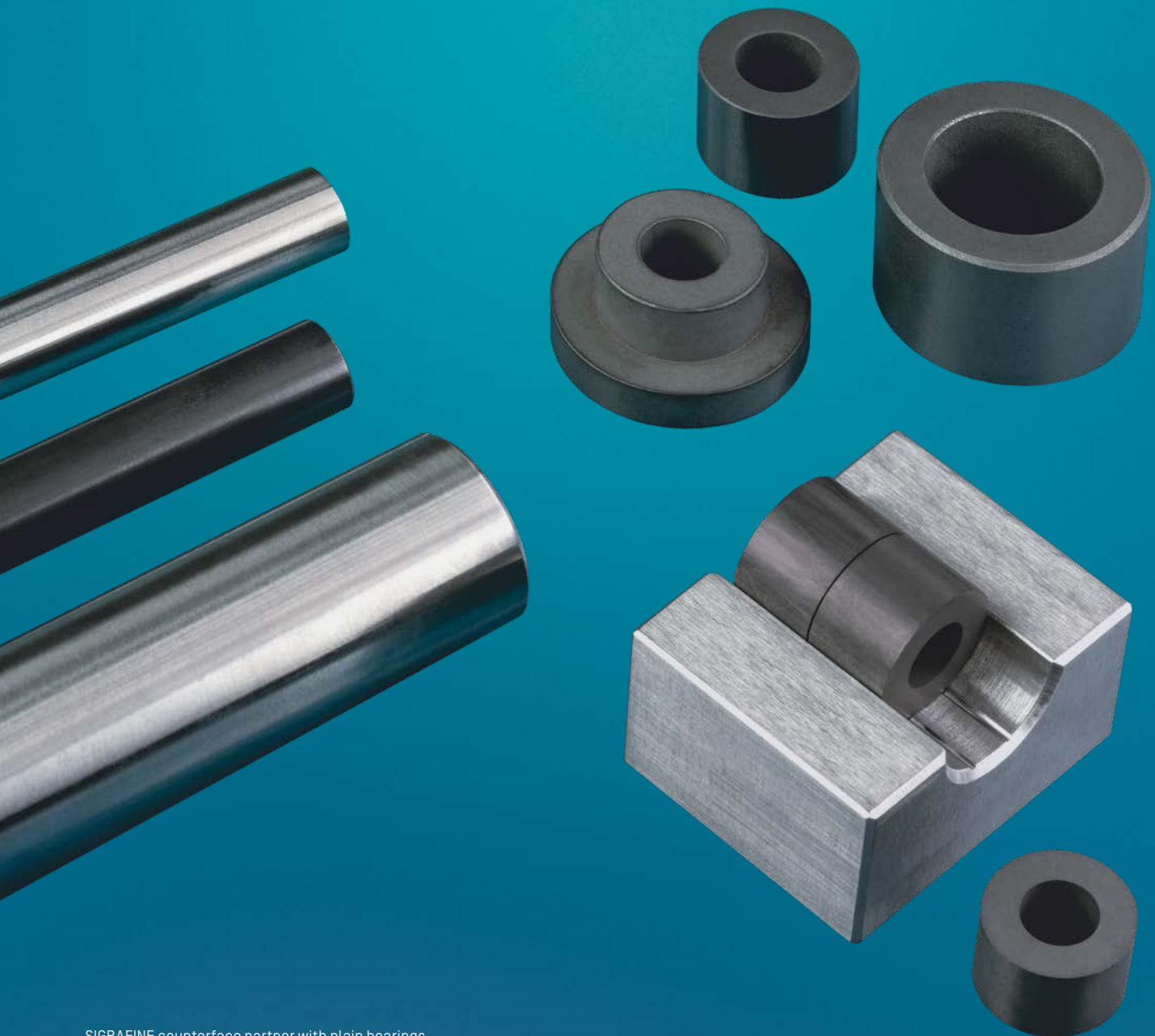

Counterface materials

For wet and dry running conditions

Our SIGRAFINE materials are suited to both conditions wet and dry running, as well as to mixed friction. In dry-running conditions, surface finish should be of a higher standard as in wet running conditions because the liquid film has a compensatory and friction-reducing effect, even in hydrodynamically poor media such as water or gasoline.

Individually adjustable for maximum performance

The selection of material type and impregnation depends on the material of the counterface. This minimizes wear and boosts cost-efficiency. The thermal expansion coefficient, for instance, can be precisely engineered to optimally align SIGRAFINE to the counterface.

We advise you

You can rely on our comprehensive know-how. By providing application-specific materials consulting in advance, we help you achieve a perfect counterface fit, which significantly enhances system performance.



↑ PTS sealing rings and mounted mechanical sealing

Recommended surface finish of metallic counterface

	v < 0.5 m/s	v < 1 m/s	v < 3 m/s
Load	p < 0.1 N/mm ²	p < 0.2 N/mm ²	p < 0.3 N/mm ²
Rz μm	≈ 1	0.5 ... 0.8	< 0.5

Recommended counterface

SIGRAFINE is especially suitable as a counterface for hard materials such as:

- Gray cast-iron
- Steel [hard], alloyed and unalloyed, as well as nitrided
- Hard metal
- Aluminum oxide
- Silicone carbide
- Glass
- DLC¹⁾-coated materials

SIGRAFINE can also be used in some cases with soft steel [alloyed and unalloyed], light-metal alloys, chromed materials, non-ferrous metal and carbon materials.

¹⁾ DLC = Diamond-Like-Carbon

Wear behavior depending on counterfaces

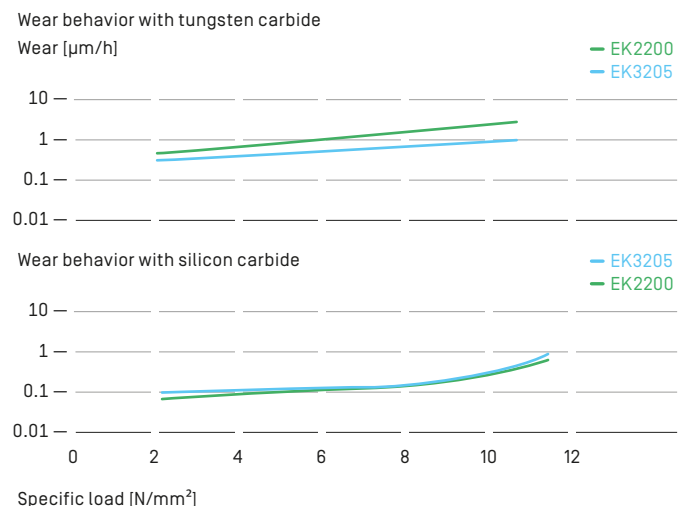

Wear behavior for counterfaces made of materials, a constant sliding speed of 9 m/s (29.5 ft/s) and increasing load. Medium: demineralized water.

Design recommendations

Proven construction designs for greater safety

The following recommendations for construction and calculation draw on our years of practical experience in projects and applications. Our design recommendations are proven performers with many years of service and help achieve maximum process reliability by minimizing such risks as broken bearings.



↑ Axial bearing of carbon-graphite for submersible motor pumps

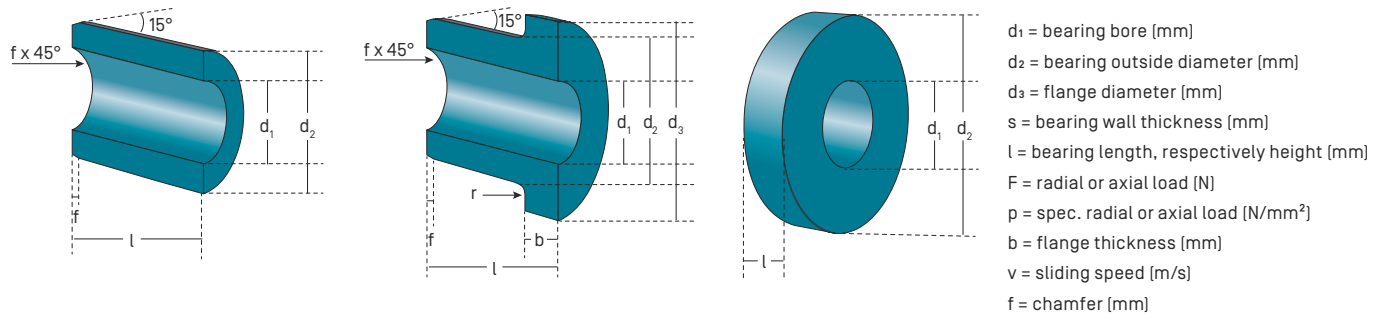

Fitting

Method of fitting	Recommended ISO tolerances		Max. Operating Temperature °C	
	d_1	d_2 Housing diameter		
Cold press fitting	before F7 after H7 ... H8	s6	H7	about 150 ¹
Shrink fitting	before D8 after E8 ... E9 ²	x8 ... z8	H7	about 300 ³

¹ For housing materials having a thermal expansion of $\alpha > 12 \times 10^{-6}/K$ the maximum operating temperature is correspondingly reduced. Press fitting is conducted with a stepped fitting pin with a tolerance of h5.

² We recommend that the bearing bore be finished to size after shrink fitting.

³ For higher temperatures and for housing materials having a thermal expansion of $\alpha > 12 \times 10^{-6}/K$ the special tolerances and/or a locking arrangement may be employed – please inquire about this.

Calculation guidelines and supplementary information

Cylindrical and flanged bearings – design guidelines and calculation

Dry running and mixed running		
Bearing dimensions	$v \text{ (m/s)} \leq 1$	projected bearing area $l \times d_1 \geq \frac{F}{0.3 \text{ (N/mm}^2\text{)}}$ $l \leq 2 d_1$
	$v \text{ (m/s)} \leq 0.1$	projected bearing area $l \times d_1 \geq \frac{F}{1.5 \text{ (N/mm}^2\text{)}}$ $l \leq 2 d_1$
Bearing clearance	0.3 ... 0.5 %	of shaft diameter at operating temperature (warm clearance)
	0.3 ... 0.5 %	of shaft diameter at operating temperature (cold clearance) if shrunk into a metal housing
Coefficient of friction	0.10 ... 0.15	for mixed running
	0.15 ... 0.25	for dry running
Wet running		
Bearing dimensions ¹	$v \text{ (m/s)} \leq 20$	projected bearing area $l \times d_1 \geq \frac{F}{0.3 \text{ (N/mm}^2\text{)}}$ $l \leq 2 d_1$
	$v \text{ (m/s)} \leq 15$	projected bearing area $l \times d_1 \geq \frac{F}{0.5 \text{ (N/mm}^2\text{)}}$ $l \leq 2 d_1$
Bearing clearance ¹	0.1 ... 0.3 %	of shaft diameter at operating temperature (warm clearance)
	0.1 ... 0.3 %	of shaft diameter at operating temperature (cold clearance) if shrunk into a metal housing
Coefficient of friction	0.01 ... 0.05	
¹ Observe the laws of hydrodynamics.		
Information for wet and dry running		
Tolerances	Outside diameter	IT 6/IT 7
	Bore	IT 7/IT 8
Surface finish	Outside diameter	Ra = 6.3 μm ... 3.2 μm
	Bore	Ra = 3.2 μm ... 0.8 μm
Bearing design	Do not subject bearing to tension, shear or bending stress	
Fitting	Cold fitting, shrink fitting, bonding	
Counterface materials (surface finish)	Generally hard materials, e. g. HRC > 50, Rz = 0.5 ... 0.8 μm	

Axial bearings – calculation guidelines and supplementary information

	Dry running and mixed running	Wet running
Bearing area A (mm ²)	$v \text{ (m/s)} \leq 1$ $A \geq \frac{F}{0.3 \text{ (N/mm}^2\text{)}}$	$v \text{ (m/s)} \leq 20$ $A \geq \frac{F}{1.0 \text{ (N/mm}^2\text{)}}$
Coefficient of friction	0.1 ... 0.25	0.01 ... 0.05
Surface finish	Bearing surfaces fine-ground to lapped	Bearing surface lapped
Bearing design	Solid or split	Solid or split, lubricating grooves
Fitting	Cold press fitting, shrink fitting, screws, nuts and form closure	
Counterface materials (surface finish)	Generally hard materials, e. g. HRC > 50; Rz = 0.5 ... 0.8 μm	

Implementation examples

Example: Axial bearing calculation

Wet running

Bearing dimensions

Bearing bore $d_1 = 20 \text{ mm}$ (given)

Bearing outside $\varnothing d_2$ By going back and calculating from the required area

$$A = \frac{F}{1.0} = \frac{500}{1.0} = 500 \text{ mm}^2$$

$$A = \frac{\pi (d_2^2 - d_1^2)}{4}$$

this results in

$$d_2 = \sqrt{\frac{A \times 4}{\pi} + d_1^2}$$

$$d_2 = \sqrt{\frac{500 \times 4}{\pi} + 20^2}$$

$$d_2 = 32 \text{ mm}$$

Bearing outside \varnothing

chosen as $d_2 = 35 \text{ mm}$

Bearing height $l > 0.1 d_2$

chosen as $l = 5 \text{ mm}$

Given values: Shaft $\varnothing 20 \text{ mm}$; Sliding speed $v = 3 \text{ m/s}$; Load $F = 500 \text{ N}$; Medium Water; Temperature 30°C

Example: Cylindrical bearing calculation

Dry running

Bearing dimensions

Projected bearing area $l \times d_1 > \frac{F}{0.3} = \frac{150}{0.3} = 500 \text{ mm}^2$

Bearing bore $d_1 > \frac{l}{2}$

chosen as $d_1 = l$
 $d_1 = \sqrt{500} = 22.36 \text{ mm}$

rounded up $d_1 = 23 \text{ mm}$

Bearing length $l = \frac{500}{23} = 21.7 \text{ mm}$

rounded up $l = 22 \text{ mm}$

Bearing outside \varnothing $d_2 = d_1 + 2s$
 $s_{\min} = 0.15 \times d_1 = 3.45 \text{ mm}$
 $23 + 2 \times 3.45 = 29.9 \text{ mm}$

rounded up $d_2 = 30 \text{ mm}$

Bearing dimensions $\varnothing 30/23 \times 22 \text{ mm}$

Bearing play

Dry running $0.3 \dots 0.5\%$ of shaft $\varnothing d$

Shaft $\varnothing 20 \text{ mm}$ $d = 23 \text{ h6}$

Bearing clearance (min.) $0.3\% \times 23 = 0.069 \text{ mm}$
{added to nominal bore}

Bearing tolerances

Bearing outside \varnothing chosen s6 [cold press fitting]

Bearing bore chosen F7

This results in: $\varnothing 30 \text{ s6} / 23.069 \text{ F7} \times 22 \text{ mm}$

Given values: Sliding speed $v = 0.5 \text{ m/s}$; Load $F = 150 \text{ N}$; Temperature 60°C



↑ Cylindrical bearing made of die-molded carbon

Design recommendations

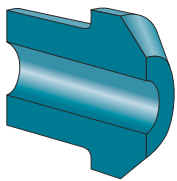

Avoid sharp steps in the bore and on the outside. Break sharp edges!

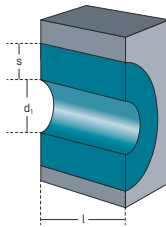

Cylinder thickness
 $l \leq 2d_1$
 $s = 0,15 \dots 0,2 \times d_1$;
 $s_{min} = 3 \text{ mm}$

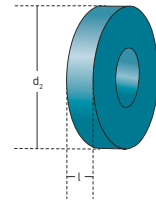

Height
 $l \geq 0.1 d_2$; not under 3 mm, if possible

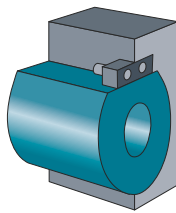
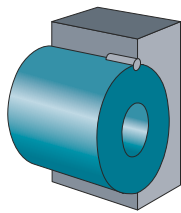
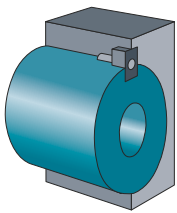

Any arrangement such as a check plate or plain pin to **prevent rotation** should be provided in an unloaded area, not in the bore. Any keyway should be axial and milled out carefully to avoid breakage.

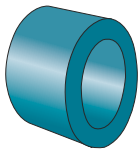

Cylindrical bearings should not be fitted to be self-supporting. They should be fully supported by the housing or by a special metal bushing.

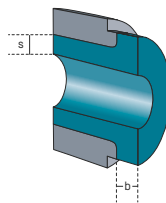

Flange thickness should be at least equal to wall thickness. A transitional angle should be radiused; machine the housing thrust face for the flange. $b \geq s$



↑ Various bearings made of die-molded carbon

SIGRAFLEX[®] and SIGRATHERM[®]

Our SIGRAFLEX and SIGRATHERM products made from flexible expanded natural graphite are specifically designed for different areas of automotive manufacturing and have been used in the most demanding applications for decades.



Highest quality standards

For manufacturing SIGRAFLEX materials, we use only high quality natural graphite, which is expanded in a thermal process and compressed without binders, adhesives or fillers. This leads to products meeting the highest quality requirements.

Performance and safety provided by quality

SIGRAFLEX is the first choice of sealing material to meet low emission standards. The proven reliability of our materials leads to increased safety in applications.

Resistance and long term stability

Products made from SIGRAFLEX are chemically resistant to the vast majority of media e.g. oils, lubricants and coolants. Oxidation inhibitors are added in some grades to additionally enhance reliability and long term stability.

Large dimensions

Our SIGRAFLEX foils are also available in large dimensions up to a width of 1.5 m [60"] in sheet or roll format allowing engineers to choose the best product for their application design needs.

Material combinations with improved properties

Graphite can easily be combined with other materials. For example, as composite material with phase change materials (PCM) products for latent heat and cold storage can be offered.

Quality features**Excellent sealing properties**

- Low permeability to gases and liquids
- Smooth temperature change behavior
- No cold or warm flow up to the maximum permissible gasket stress

Stability

- Excellent resistance to chemical media and temperature
- Absence of binders means no ageing, fatigue or embrittlement

Anisotropic properties

- High in plane electrical and thermal conductivity

User benefits

- Low density
- Soft and flexible, easy to process and to adapt to surfaces
- Non-flammable
- No health risks and environmentally friendly

Custom-designed features of our SIGRAFLEX® and SISRATHERM® products

	SIGRAFLEX					SISRATHERM			
	Foil	HD foil	synthetic graphite foil	GFG	L	ePCM	L/PCM	GFG/PCM	PTS PCM
Gaskets	●								
Bearings for EGR valves	●								
Conductivity additives				●					
Heat/cold storage						●	●	●	●
Heat/cold transfer	●	●	●		●				

SIGRAFLEX® flexible graphite for sealing applications



↑ SIGRAFLEX APX2 products for a wide range of automotive applications

Government regulations are continuously requiring automotive and large diesel engine manufacturers to reduce CO₂, NO_x and diesel particulate emissions at even higher combustion temperatures.

For high demands

SIGRAFLEX flexible graphite grades are used in sealing applications which demand great durability, reliability, safety and impermeability and call for resistance to extreme temperatures and enhanced sealing characteristics.

Extremely versatile

Our flexible graphite foil is available in various densities and can be adapted to a wide variety of sealing applications with great versatility like cylinder head and exhaust system gaskets. SIGRAFLEX is suitable for highly automated manufacturing of engine technology gaskets and seals and mass production.

Material data of our SIGRAFLEX® graphite foils¹⁾

Typical properties	Test method	Unit	SIGRAFLEX			
			APX2	APX	AP	A
Thickness	ASTM F104	mm in	0.25 – 1.52 0.01 – 0.06	0.35 – 1.00 0.014 – 0.04	0.25 – 2.00 0.01 – 0.08	0.25 – 2.00 0.01 – 0.08
Purity	ASTM D5373	%	≥ 98	≥ 98	≥ 98	≥ 95
Ash content	ASTM C562	%	≤ 2	≤ 2	≤ 2	≤ 5
Density	ASTM C599	g/m ³ lb/ft ³	1.0 – 1.12 62.4 – 70.0	0.7 – 1.00 43.7 – 62.4	1.0 – 1.12 62.4 – 70.0	1.0 – 1.12 62.4 – 70.0
Sulfur content	ASTM D42398	ppm	< 300	< 300	< 300	
Leachable chloride content	ASTM D4327/D5542	ppm	≤ 25	≤ 25	≤ 50	≤ 50
Oxidation inhibitor			yes	yes	yes	no
Weight loss in air at 670°C (1238°F) [TGA] ¹⁾	ASTM D7582 LECO TGA	%/h	≤ 1	≤ 3	≤ 2	

¹⁾ Values for material thickness ≥ 0.5 mm and density ≥ 1.0 g/cm³

SIGRAFLEX® APX2 – absolute top numbers

SIGRAFLEX APX2 foil was developed to meet rigorous demands and is currently being used in a wide range of sealing applications including:

- Exhaust gasket rings
- Exhaust gas recirculation (EGR) bearings
- Gaskets for diesel particulate traps

Unmatched performance on the market

SIGRAFLEX APX2 flexible graphite foil meets the increasing temperature requirements in modern exhaust systems. It has extremely little weight loss due to oxidation even at high temperatures [typical only 0.6% per hour at 670 °C]. Our proprietary oxidation inhibitors and production process allow the inhibitors to be incorporated into the structure of the graphite foil, fully optimizing the oxidation resistance behavior. This is unmatched performance in the industry.



↑ SIGRAFLEX flexible graphite foil for automotive applications

APX2 1800 times tighter than mica after 5h at 500°C [932°F]

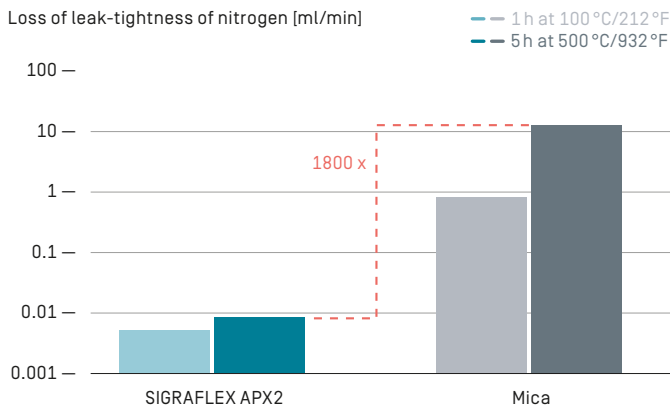

Relative weight loss of SIGRAFLEX foils: APX2 is “Best in Class”

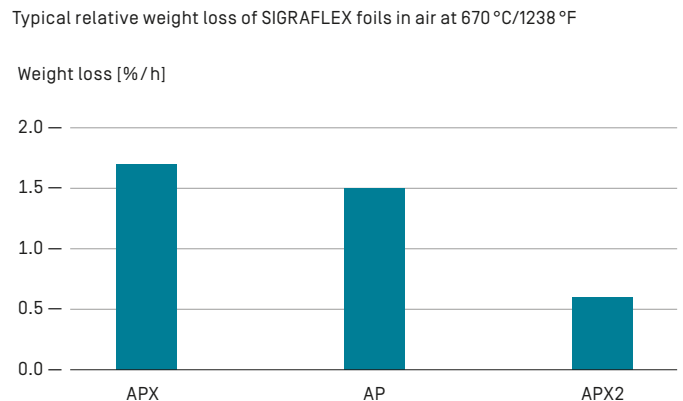

SIGRATHERM® flexible graphite products for automotive thermal management



↑ SIGRATHERM ePTS sheet manufactured from flexible graphite and encapsulated PCM, also available as pressed-to-size component

SIGRATHERM products made of flexible graphite are designed to meet the old and new challenges of mobility. Especially new powertrain systems require new concepts for thermal management.

We use our experience we have made in the sealing business to develop products suited to the demands of tomorrow – in particular in the field of intelligent thermal management in order to support CO₂ reduction, longer lifetime of components, reduction in energy consumption, increased safety, and enhanced customer satisfaction.

Intelligent thermal management

Wherever heat or cold has to be managed or stored under extreme conditions within the vehicle, SIGRATHERM products made of flexible graphite can provide solutions – due to their high thermal conductivity and their fast response characteristic compared to standard heat management systems. Graphite is suitable for heat and cold transport and dissipation as well as for heat and cold storage.

Thermal conductivity of SIGRATHERM HD foil exceeds the performance of copper

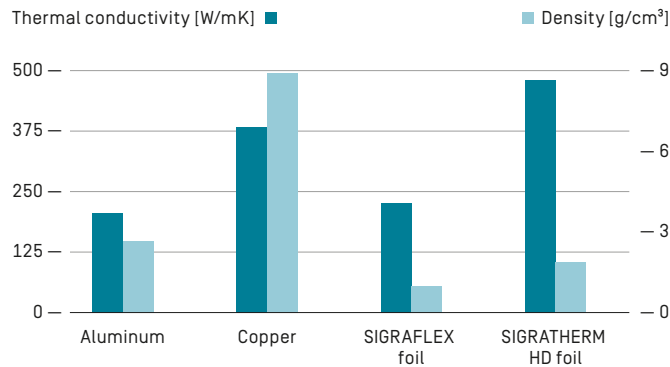

The thermal conductivity of SIGRAFLEX foils is strongly direction dependent (anisotropy) and can thus be regulated

Thermal conductivity of SIGRAFLEX foils as a function of density (at room temperature), left: parallel to surface, right: perpendicular to surface

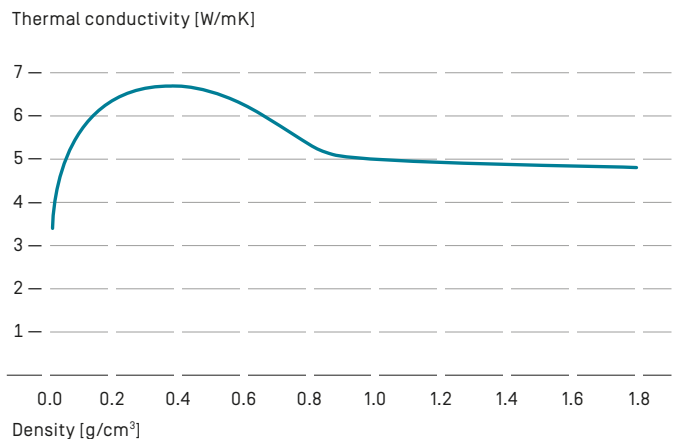
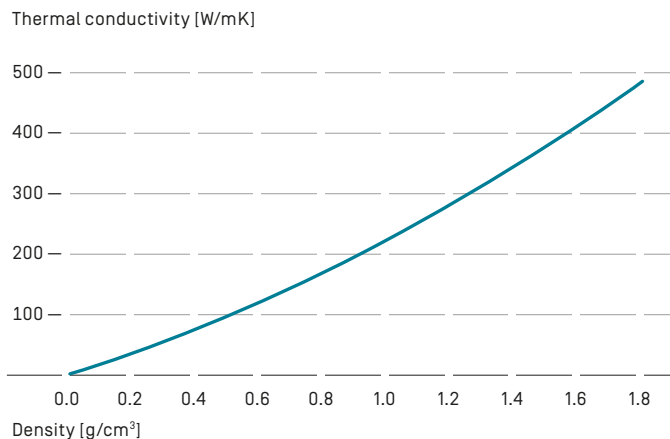



↑ SIGRATHERM L sheet filled with PCM and powder GFG 5

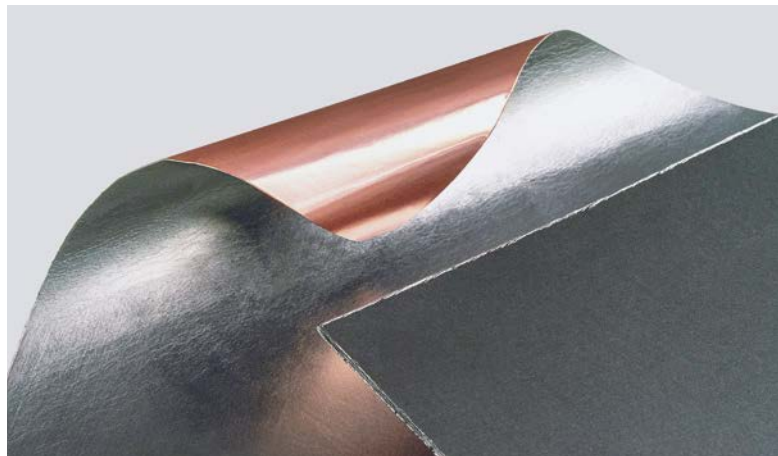

↑ SIGRATHERM graphite/copper composite and HD sheet

Graphite/PCM combinations for storage

When excessive heat or cold needs to be buffered and re-used afterwards, very often Phase Change Materials (PCM) come into play, despite their very low thermal conductivity. A combination of graphite and PCM is here the best choice: Graphite/PCM composite materials allow for production of high performance heat and cold storage systems since graphite increases the thermal conductivity of the PCM and leads to faster reaction times. Another customer benefit is the temperature stabilization leading to increased passive security.

No leakage, easy processing

Our proprietary material combination and process set-up ensures that PCM material cannot leak out of the product – a well-known problem for a long time – and our products can be easily cut-to-size or even pressed-to-size. Fusion enthalpy and melting point can be adjusted by selecting the right phase change material for the application.

Customer specific material combinations

Due to our long-standing experience in the field of flexible graphite, we are able to customize material characteristics and combine different materials in order to provide the solution for our customers' needs. Just ask us!

Low density – reduced consumption

Reduction in energy consumption goes in line with weight reduction of the entire vehicle: due to the low density of flexible graphite, solutions show a great potential to reduce total weight. Flexible graphite demonstrates by far lower densities than standard materials like aluminum or copper.

Properties of expanded graphite/PCM compound materials

Typical properties	Unit	Expanded graphite/PCM compound materials			
		ePCM28	Slurry, GFG1200	L/PCM5	PCM10
Max. dimensions	mm	15x300x300		140x170x170	140x170x170
	in	0.6x11.8x11.8		5.5x6.7x6.7	5.5x6.7x6.7
Density	g/cm³	0.85	0.8	0.5	1.0
Flexural bending strength	MPa/Psi	2.0/290			
E-modulus	MPa/Psi	105/15,200			
Thermal conductivity	W/mK	5.0	3.5	100	220
	W/mK ⊥	2.5	3.0	7.0	5.0
Heat storage capacity	J/g	140 [28°C/82°F]	120 – 150 [adjustable]	80 – 100*	60 – 80*
Melting point*	°C	28 – 65	5 – 102	5 – 102	5 – 102
	°F	82 – 149	41 – 216	41 – 216	41 – 216

* Depending on the phase change material used

Successful together

We do more than just manufacture products. We pride ourselves on offering intelligent and enduring solutions for our customers.

Our comprehensive know-how in different areas of application make it possible. By working in close conjunction with our customers and understanding their specific requirements, we develop new, forward-looking solutions, as well as responses to specific needs.

This has given rise to most of our innovations, such as our SIGRAFINE V2064 and V2142 material.





[Less e]mission possible

The recirculation of partially combusted exhaust gases reduces fuel consumption and emissions. This makes an important contribution to more environmentally friendly mobility. At the same time, the higher temperatures needed in this function pose significant challenges for the used parts.

With this in mind, we developed a material for use in valves for exhaust gas recirculation systems that is precisely tailored to these ambient conditions: our specialty graphite SIGRAFINE V2064. It is extremely oxidation resistant and stable over long periods even at temperatures up to 600 °C.

This product is our reaction to a stated need on the part of our automotive customers. Beyond this, our use of pressed-to-size [PTS] technology allows us to deliver parts that are almost perfectly matched with their final form, reducing the need for post-production machining. This saves time and money – and is a good example of our intelligent, application-focused solutions.

Smart Solutions

Be it materials, components or production processes, we focus our thinking and actions on the customer and keep an eye on the big picture. Our solutions already anticipate the future today.

The following examples show a selection of our unique product range.

Mobility

- Lightweight components and structural parts based on fiber-reinforced composites for automotive and aerospace manufacture
- Graphite anode material for lithium-ion batteries in electric vehicles
- Carbon-ceramic brake disks for sports cars and luxury sedans

Energy

- High-temperature solutions based on specialty graphites and fiber materials for the photovoltaic industry
- Carbon fiber materials for rotor blades
- Gas diffusion layers for fuel cells
- Systems for more efficient heat exchange and heat recovery
- Carbon fibers for pressurized gas containers

Digitization

- Carbon, graphite, and CFC components for polysilicon and monocrystal pulling in the semiconductor industry
- High precision, coated graphite carriers for the production of LEDs

→ State-of-the-art green production with the world's largest isostatic press



SGL Carbon

We are leaders in the development and manufacture of products based on carbon, graphite, carbon fibers, and fiber-reinforced composites. In partnership with our customers, we develop intelligent, trendsetting, and sustainable solutions that deliver a clear benefit.

With our in-depth material, engineering, and application know-how, we make a substantial contribution to the major future topics mobility, energy, and digitization.



Contact

Europe / Middle East / Africa

SGL CARBON GmbH
Drachenburgstrasse 1
53170 Bonn/Germany
mechanical-europe@sglcarbon.com

Americas

SGL CARBON LLC
900 Theresia Street
PE 15857 St. Marys/USA
mechanical-america@sglcarbon.com

Asia / Pacific

SGL CARBON Far East Ltd.
151 Huan Chen Dong Lu
Shanghai Fengpu Industrial Development Zone
201401 Fengxian/China
mechanical-asia@sglcarbon.com

® registered trademarks of SGL Carbon SE

This information is based on our present state of knowledge and is intended to provide general notes on our products and their uses. It should therefore not be construed as guaranteeing specific properties of the products described or their suitability for a particular application. Any existing industrial property rights must be observed. The quality of our products is guaranteed under our «General Conditions of Sale».

10 2018 / 1 E Printed in Germany



Graphite Materials & Systems
SGL CARBON GmbH
Soehnleinstrasse 8
65201 Wiesbaden/Germany
www.sglcarbon.com/gms